

## • Table of Contents

Operation and Quick Start Guide	2-3
Safety	4
Admin	5-8
Alarms	9
Bargraph	10
Clock	11
Damping and Datalogging	12
Datalogging	13
Display	14-15
Leak Test and Min/Max	16
Sensor	17
Snapshot	18
Tare	19
Units	20
Data Management Application	21-23
Specifications	24-27
Range Options	28-29
Model Configurator	30
Range and Resolution	31
Service and Warranty	32

## • Introduction

Thank you for choosing the Vaetrix Test Gauge. Vaetrix is engineered by individuals that have been in the process control industry for well over twenty years. We take pride in the fact that our products are designed and manufactured in the USA. The gauge itself is backed by an industry leading four-year warranty. Our products are designed and built to take abuse. We would have it no other way.

The only way we can get better is by listening to you, the customer. If you have any comments or suggestions feel free to send us an email at [sales@vaetrix.com](mailto:sales@vaetrix.com) or call at 888-797-3740.

## • Brief Overview

The gauge is powered by 3 AA alkaline batteries that provide over 1000 hours of continuous use. To replace the batteries just remove the two screws located in the battery door. The gauge is sealed to meet IP-65 so make sure the battery door screws are tight. Communications for datalogging and downloads is handed by USB. A standard USB to Micro B cable will work. For further details on all important measurement parameters consult the specifications section in the manual.

When the power key is pressed down the gauge enters the boot-up sequence.

Gauge firmware revision, range, serial number, and contact information will be displayed for two seconds.

Once complete the gauge is actively reading pressure in Measure Mode.

There are two modes of operation:

*(Measure)*

The Measure Mode keys ZERO, UNITS, and SNAPSHOT are active.

The backlight will automatically turn On with any key press and remain on for 60 seconds. Backlight settings can be changed in Program Mode under DISPLAY.

*(Program)*

Simply press and hold the DOWN arrow to access *Program Mode*. Use the ARROW keys to navigate and SELECT to confirm. The quick overview below shows you all the available menu options.













MAIN MENU	OPTIONS
ADMIN	Control Features, Reduce Resolution, Adjust Calibration, Restore Factory Calibration
ALARMS	On/Off/Set High or Low
BARGRAPH	On/Off
CLOCK	Set Date, Time, Time Zone, and Format
DAMPING	On/Off
DATALOGGING	Start, Configure
DISPLAY	Timeouts, Contrast, Refresh Interval, Color
LEAKTEST	Start, Stop
MINMAX	Reset
SENSOR	Gauge or Absolute
SNAPSHOT	View
TARE	Live, Offset, Reset
UNITS	Lock, Scroll, Unlock



## • Safety

We use the International Electrical Symbols on our products and in the manuals to alert users of key criteria that must be followed when operating the product.

Symbol	Description
	Power Off / Power On
	Earth Ground
	Warning, Risk of Danger or Damage
	European Conformity
	Hazardous Voltage
	Battery Symbol
	Wheelie Bin, Conforms to EC Directive for Disposal

-  Use a #2 phillips screwdriver when tightening the battery door screws to prevent stripping and provide adequate sealing.
-  Use backup wrench on pressure sensor to install or remove fitting.
-  Gauge is not approved for use in hazardous locations.
-  To clean the gauge, wipe down with damp cloth and small amount of dish soap. Do not submerge the unit in water at anytime.

- Admin

In the Admin menu you have the ability to CONTROL FEATURES, REDUCE RESOLUTION, ADJUST CALIBRATION, or RESTORE FACTORY CAL. A password must be entered to gain access to these features. The default password is 2017. Use the ARROW keys enter in the value and press the SELECT key.



- Admin - Control Features

The menu options in the gauge can be locked out according to your preferences.

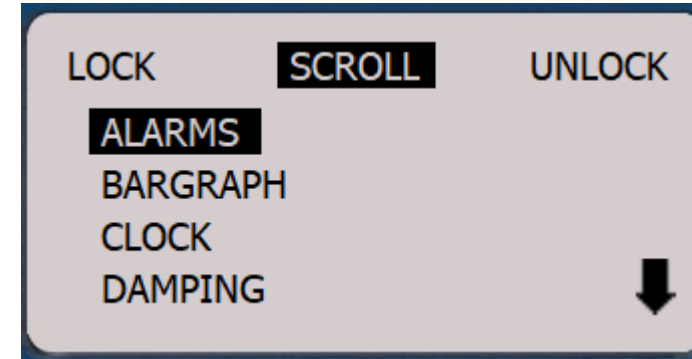

SCROLL using the up or down ARROW keys to highlight the options. Use the right or left ARROW keys to LOCK or UNLOCK. The end user will enter password to UNLOCK.

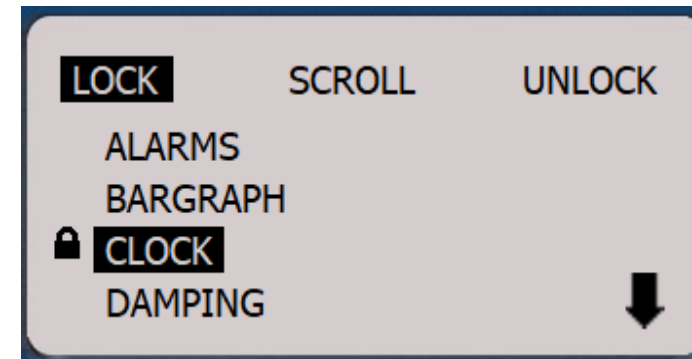

- Admin – Reduce Resolution

The least significant digit will be removed from the display when selecting REDUCE RESOLUTION. This feature can be useful for recording values and pulsating pressure if damping is not used. Full resolution can be restored by entering back in Admin and selecting INCREASE RESOLUTION.

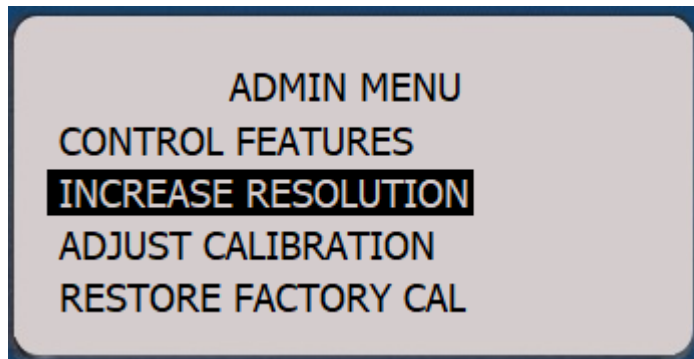
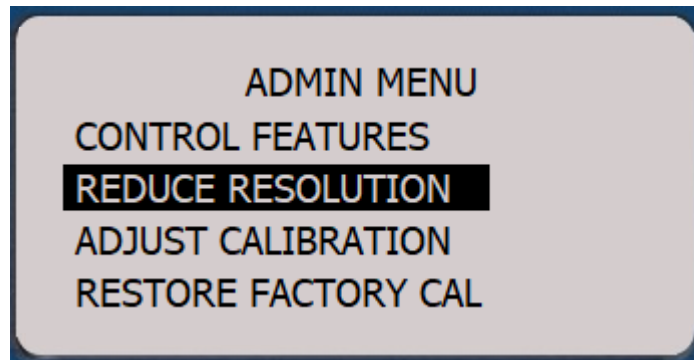

- Admin – Adjust Calibration

We recommend calibration on an annual basis. Calibration frequency should be determined by your quality system based on history, usage, and other key criteria.

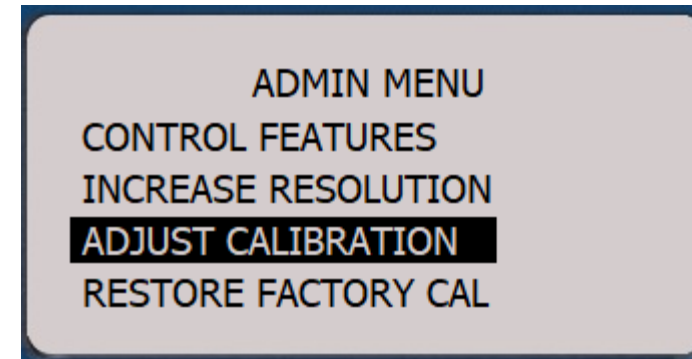

Although we suggest you return the ETG to factory for calibration, you can field calibrate the unit with trained personnel and equipment traceable to the National Institute of Standards and Technology (NIST). To begin the process select ADJUST CALIBRATION.



- Admin – Adjust Calibration

The unit will prompt you to apply the high reference pressure. We recommend that you are within 10% of the high pressure reference setpoint. Enter in the known value by using the ARROW keys to increase or decrease digits and confirm with the SELECT key.

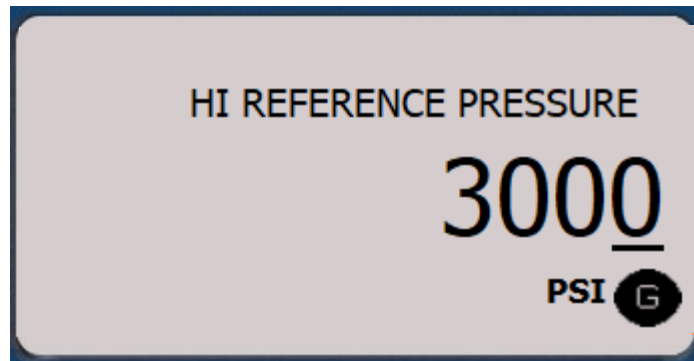

Follow the same steps for the low pressure reference setpoint. Once again, we recommend you are with 10% of the setpoint.

- Admin – Adjust Calibration

The unit will respond by with “Storing Calibration” and return to Measure Mode.

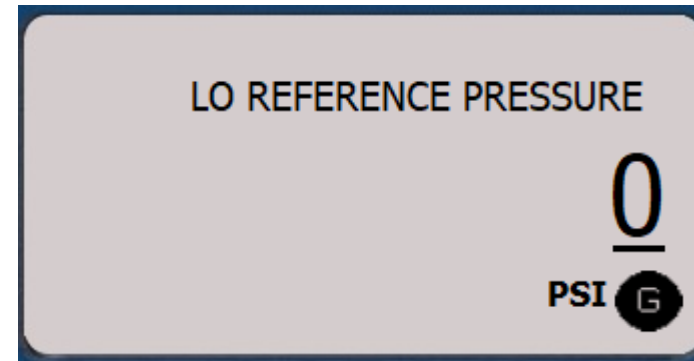

Certain pressure ranges may have more than two pressure reference setpoints. Follow the same procedure of entering in the known value and confirming with SELECT key. Once the calibration is complete verify the gauge is within specification by the running the up and down scale throughout range. Reference the original Certificate of Calibration for cardinal points.

- Admin – Restore Calibration

If you make a mistake during the calibration process or the gauge is not within specification the factory defaults can be restored. Navigate to RESTORE FACTORY CAL and press the SELECT key. The unit will respond by with “Storing Calibration” and return to Measure Mode.

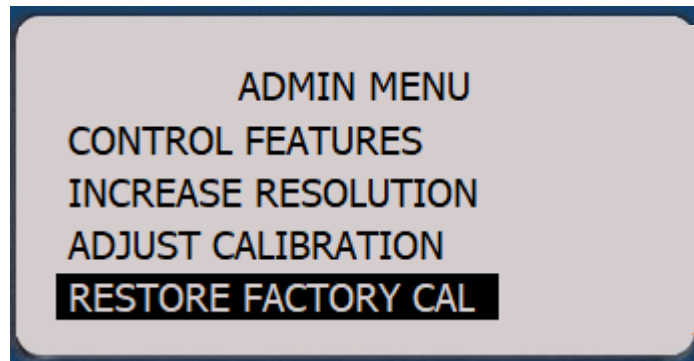

Contact the factory if you are having any issues with calibration.



- Alarms

The ETG can be setup to indicate a Low and High Alarm. Once the low or high value is reached the display or value will turn red until the pressure changes. To adjust an alarm select Low or High Alarm and then SET. To set the alarm value use the right or left arrow keys to select the decimal place and the up and down are keys increase or decrease the value. Press SELECT to confirm the value and return to the selection menu.

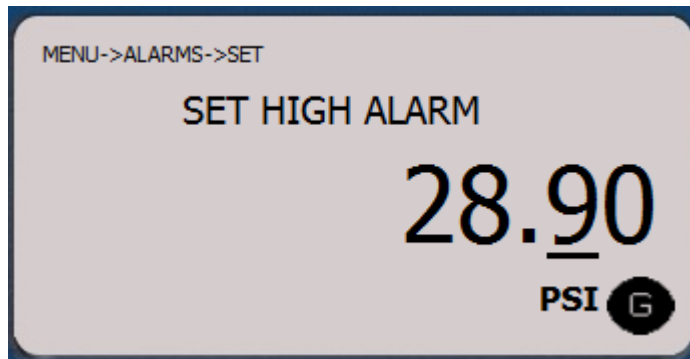

Once the alarm setpoint has been reached the high or low alarm icon will show on the display and background color will change to red to indicate an alarm status.

To disable an alarm, choose OFF and SELECT.

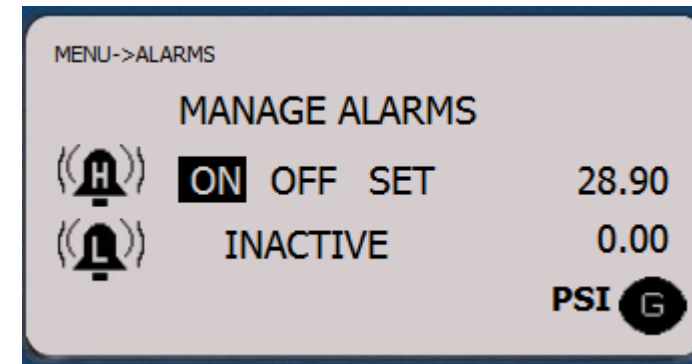

- Bargraph

The bargraph on the left-hand side of the display indicates the pressure value from 0% to 100% based on the pressure range of the gauge purchased. It is an excellent reference tool to remind the end user of the safe working pressure and is broken down into ten segments.

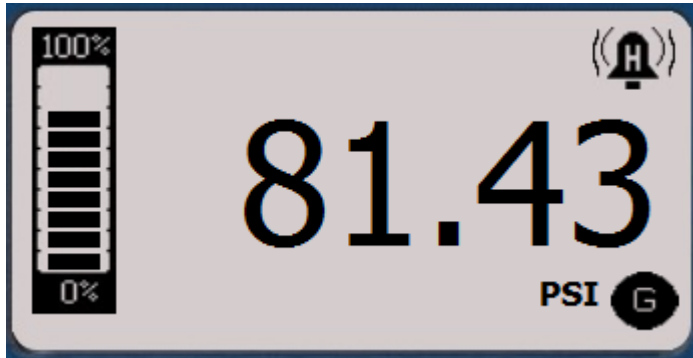

If you prefer not to use the bar graph, it can be turned OFF by using the RIGHT arrow key and pressing SELECT.

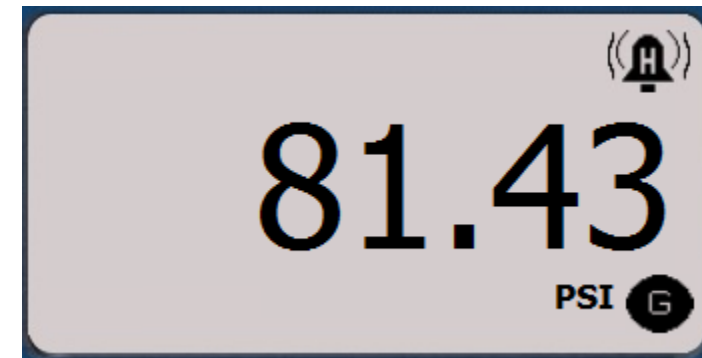
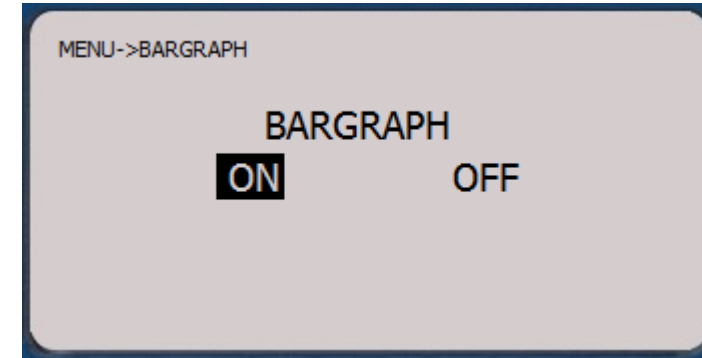

- Clock

A unique feature of the ETG is a real time operating clock for data logging or recording events. The unit will keep time even when the standard AA batteries are replaced. To set the Date, Time, Time Zone (Daylight saving time), or Time Format use the ARROW keys to highlight the choice and press SELECT.

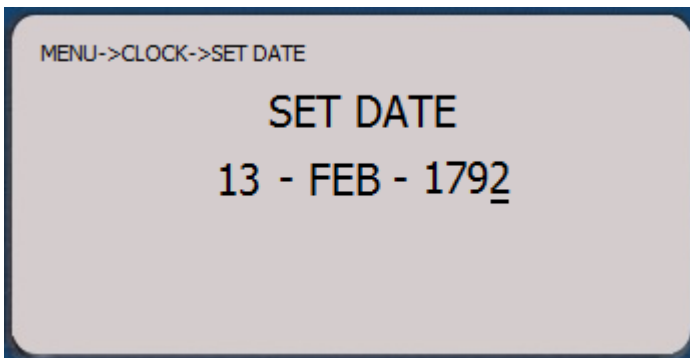
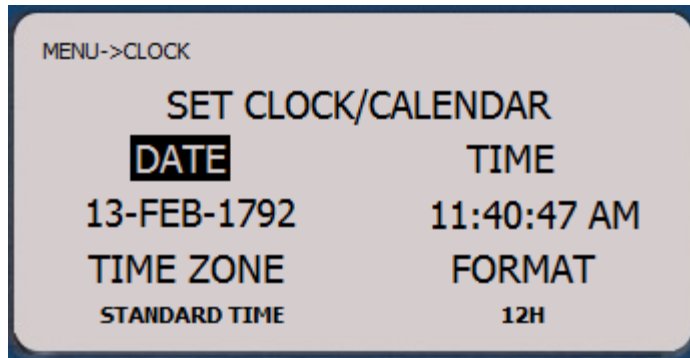

Make sure that gauge is set to match the PC to avoid any syncing issues with time when uploading or downloading data.

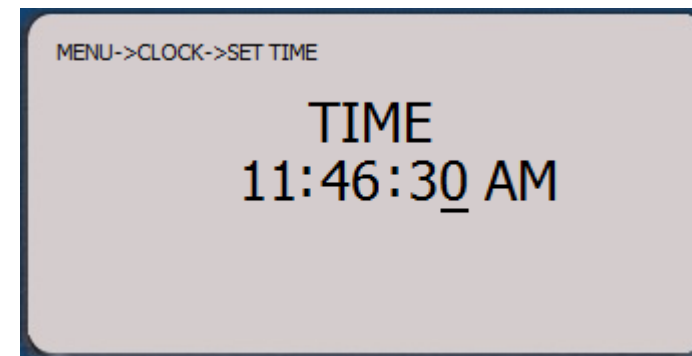

- Damping

Damping is designed to average out pulsating pressure and smooth out the pressure signal so that it is readable on the display.



- Datalogging

The test gauge has the capability to store up to 64000 pressure readings in up to 200 unique sessions in the internal non-volatile memory. In datalogging mode, the current sample rate and how many hours the gauge can record before the memory is at capacity is shown. At Low Battery Indication the unit will shut down the datalogging feature.

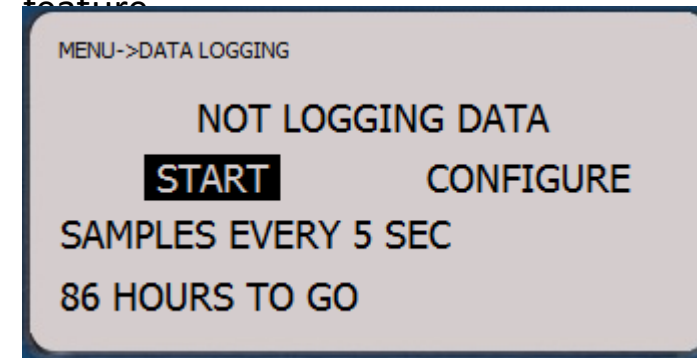

To change settings select CONFIGURE. The sample rate can be set from 1 second to 24 hours. Just use the arrows key to desired value and press SELECT to confirm.

- Datalogging

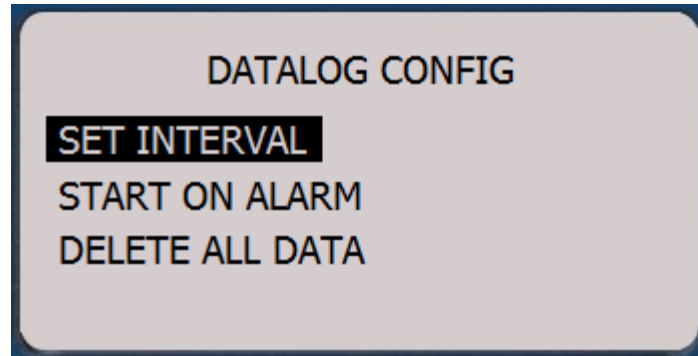

Datalogging can be setup to automatically start on an Alarm condition as well. Simply choose START ON ALARM and press SELECT. Datalogging will start based on either the High or Low alarm setting and run at the defined interval from that point forward. Clearing the alarm will not turn off Datalogging.

DELETE ALL DATA will erase all the logged data on the unit. Use the UP arrow key or HOME to escape.



- Display

The ETG has an active graphics display that can be setup based on your preferences.

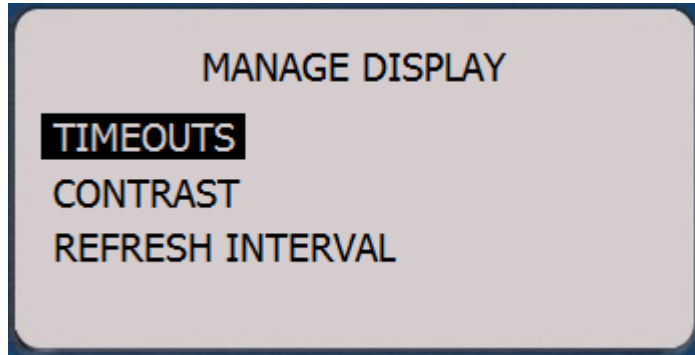

Under TIMEOUTS the DISPLAY or LIGHT can be set to turn off to conserve battery life. Intervals can be set anywhere from ten seconds to thirty minutes of inactivity.



Just choose SET and press SELECT to define the interval. Use the left or right arrow keys to move the cursor and up and down arrow keys to set the value.

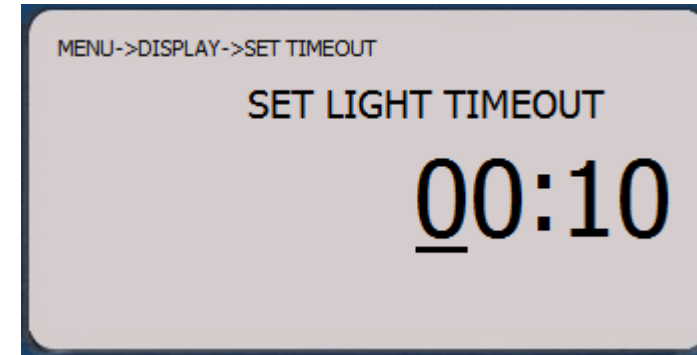

Press SELECT to confirm the value. The status in the menu will change from INACTIVE to ACTIVE denoting the current state.

Certain lighting conditions may require an adjustment to the display contrast for optimum viewing. Use the Up and Down arrow keys and bargraph indicator to set the contrast. Press SELECT to confirm the setting.

- Display

Certain lighting conditions may require an adjustment to the display contrast for optimum viewing. Use the Up and Down arrow keys and bargraph indicator to set the contrast. Press SELECT to confirm the setting.



The refresh interval or how the graphics display is updated can be set to the user's preference. The default setting for the gauge is REALTIME. This means the gauge updates up to 4 times a second depending on loading.

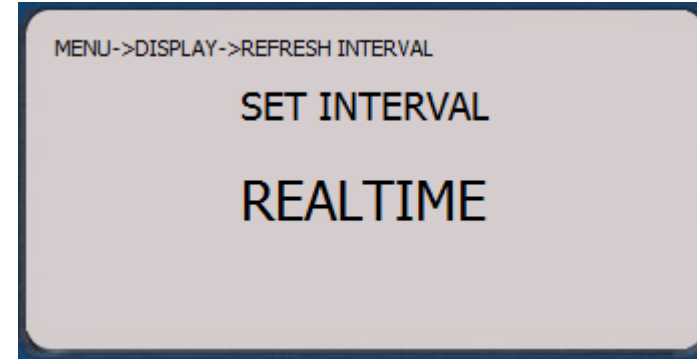

If a high update rate is not needed the interval can be extended to conserve battery life. To adjust the refresh intervals in seconds, use the Arrow Keys and press SELECT. The interval can be set to a maximum of thirty seconds.

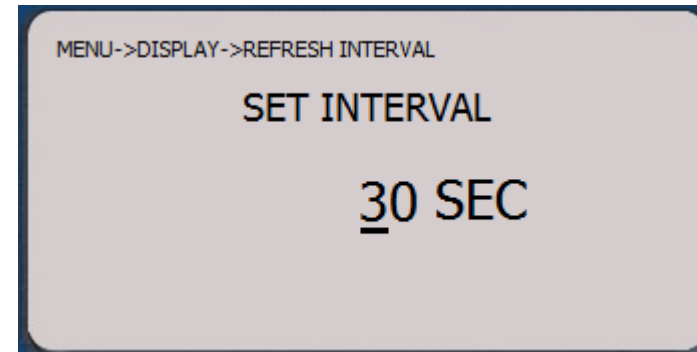

The display backlight color can be changed from Blue to Green.



- Leak Test

Pressure leak testing is used in many applications to verify product or process integrity. Once Leak Test is selected from the menu selection a test will start.



To stop the test at any time press right arrow to highlight STOP. When the test is complete, the gauge will display the leak rate in units/minute. In addition, the results with start time and end time are displayed until the next test is started. Minimum test time is 10 seconds. To start a new test use the left arrow key.



- Min/Max

The ETG tracks the Maximum and Minimum pressure readings from the time the unit powers on or the data was last reset. MAX, MIN and LIVE pressure readings can be viewed all on one screen. Just choose MINMAX from the main menu and the following screen will appear. To reset the values press the SELECT key.



- Sensor

A unique feature that sets the ETG series apart from the competition is the ability to display Absolute or Gauge pressure from single unit.

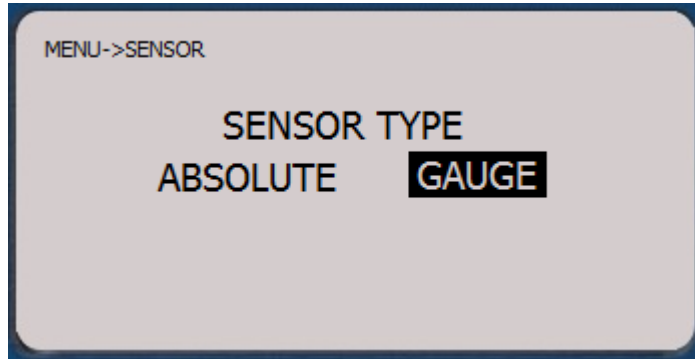

Absolute pressure is referenced to a perfect vacuum so it's equal the sum of Gauge pressure and Atmospheric pressure. Gauge pressure is always referenced to atmosphere. It is always crucial to perform a zero before attempting a calibration to eliminate any errors that may be caused by fluctuating pressure or changing conditions.

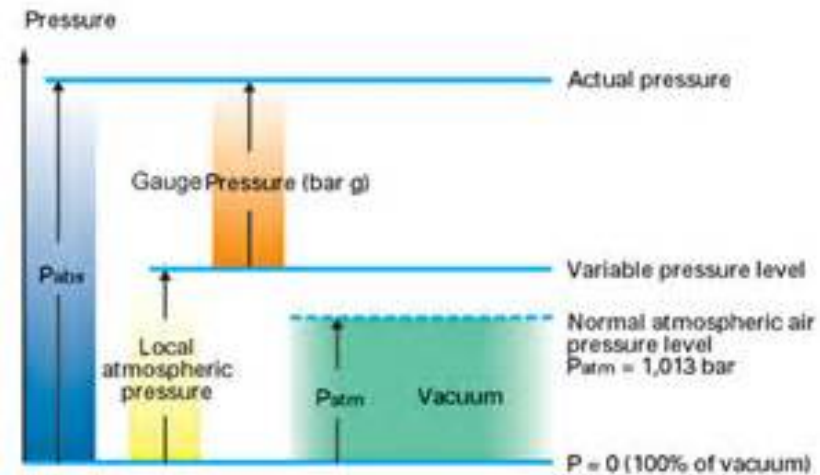

Just make your choice and press the SELECT key. The engineering unit chosen will be followed with A (absolute) or G (gauge).

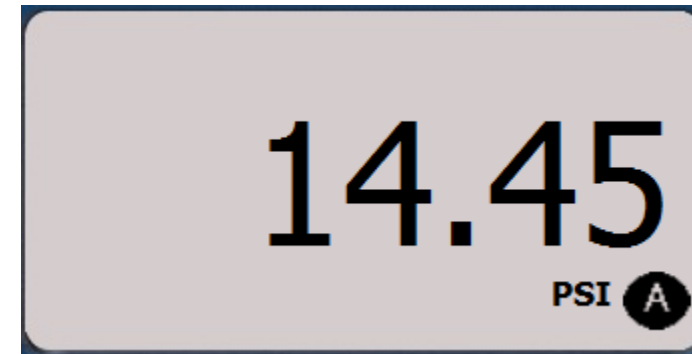

- Snapshot

If you look carefully at the keypad on the ETG you will notice a camera icon next to right arrow key. The snapshot feature is a quick way to capture and record pressure readings while in Measure Mode. Just press right arrow key and you will notice the camera icon appearing for one second to note a picture was taken with a date and time snap. Up to twenty snapshots can be taken and stored. To view the pictures select SNAPSHOT in program mode.

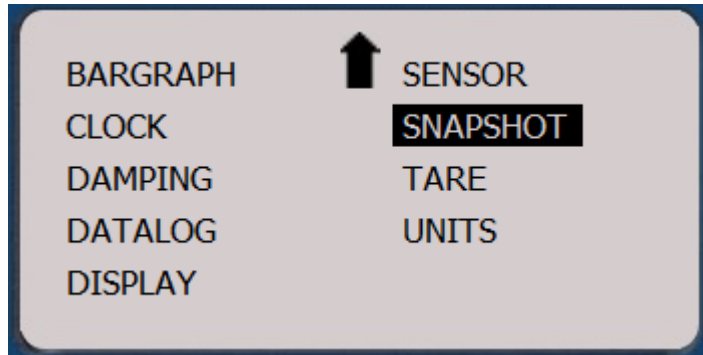

The date and time is stored with each snapshot. Any new snapshots taken will overwrite the oldest stored in memory.

Use the Up and Down arrow to scroll through the readings.

- Tare

The tare feature lets you deduct a pressure value from live pressure. Applications where existing pressure can't be removed and must be accounted for are perfect for the tare feature. For example, measuring level in tank based on hydrostatic pressure using a dead leg.

Tare is indicated in Measure Mode when applied.

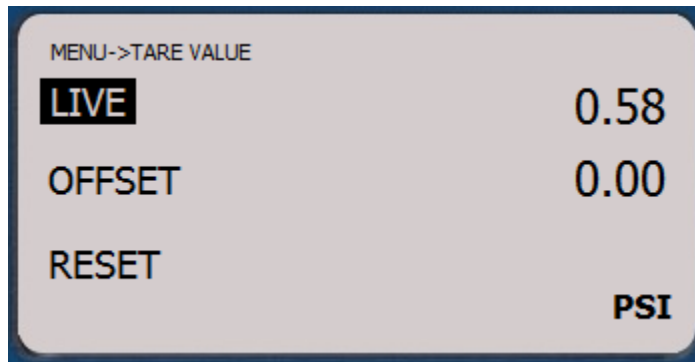

Manual tare values can be set by selecting OFFSET.

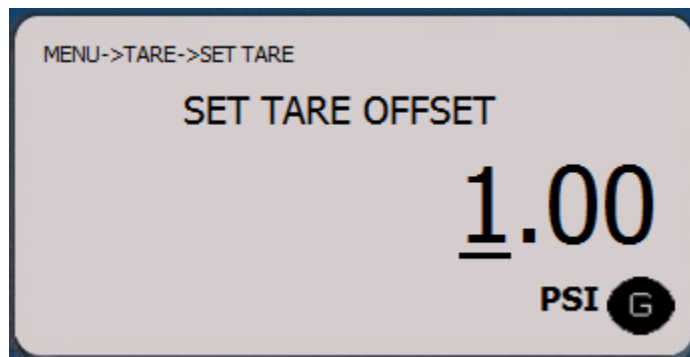

- Units

There are twenty three selectable engineering unit available to choose from. In *Measure Mode*, press the UNITS key and use the ARROW keys to scroll through the options.

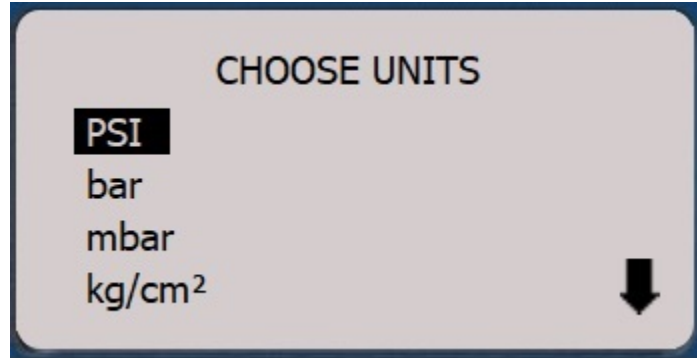

Press the UNITS key to accept the selection and the gauge will return to *Measure Mode*.

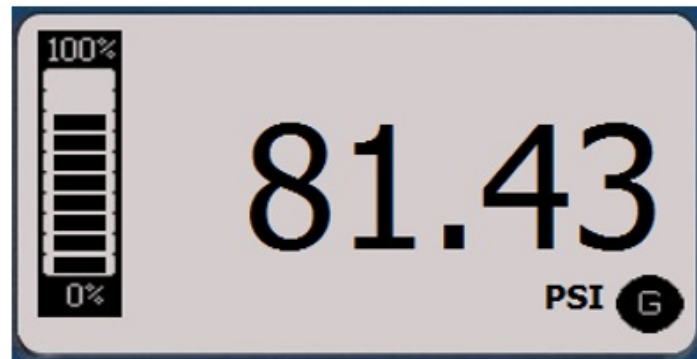

If you would like to focus on a couple different engineering units or prevent certain users from using an unapproved choice for calibration, units can be locked or unlocked under Units in *Program Mode*.

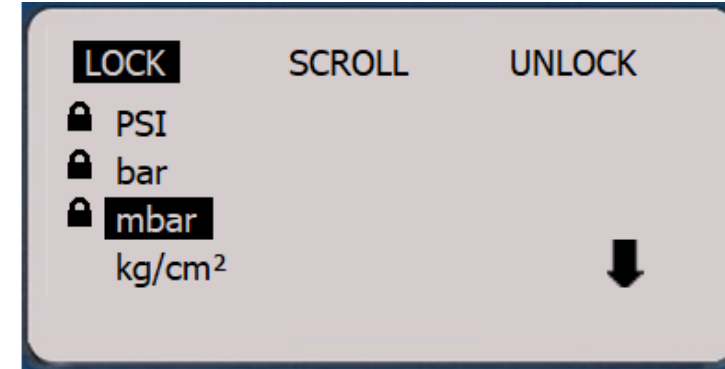

Use the right or left ARROW keys to highlight LOCK, SCROLL, or UNLOCK. Use the up or down ARROW keys to either LOCK, SCROLL, or UNLOCK the engineering units, depending on which function is highlighted.

- Datalogging Application

Turn your ETG into a full blown datalogger with the optional Data Management Software. The software application can be downloaded free at [www.vaetrix.com](http://www.vaetrix.com). You can use it for free on a limited basis. If you would like to use the full capabilities, contact Vaetrix for details.

The Data Management Software is very easy to use. Datalogging sessions can be started with just one click. Simply connect the gauge with the USB cable. The software will automatically recognize the gauge and appear at the top of the software with the Model and S/N. If there is more than one gauge connected to the PC the SN will appear in the dropdown selection.

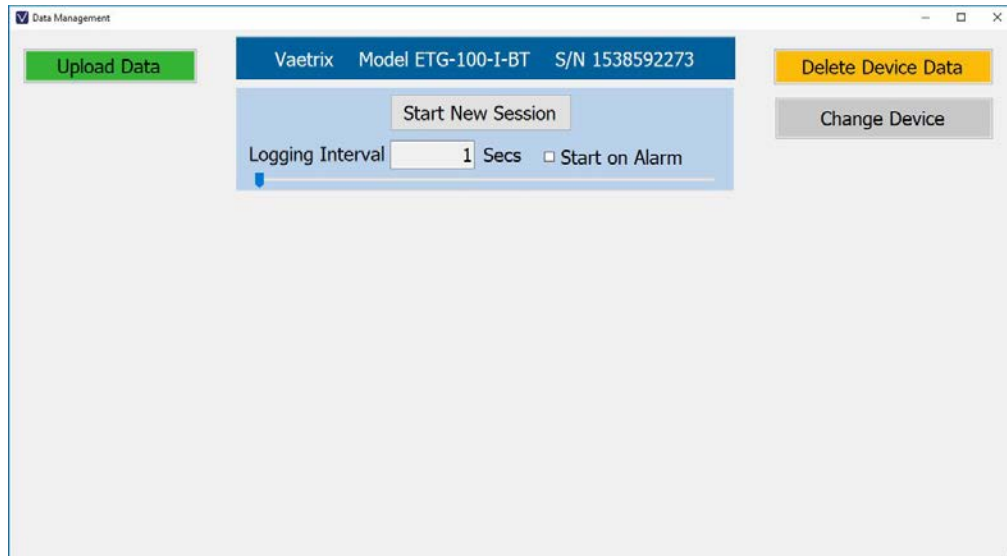

To start a new session simply use the slider bar or type in value to set the logging interval from one second to twenty-four hours and then press the Start New Session button. A session can be ended at any time by clicking Stop Session. If the High or Low Alarm values are enabled in the ETG, datalogging can be started automatically.

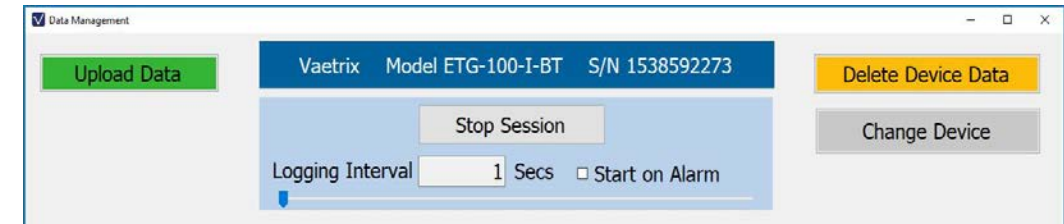

Just check the Start on Alarm condition next to the Logging Interval.

To retrieve sessions from the gauge press the Upload Data button. The gauge can store up to 200 unique sessions or 64,000 samples. Click the Delete Device Data button to clear the entire gauge logging directory. Please remember to save any sessions to the PC for recall before Deleting Device Data.

- Datalogging Application

Sessions will be listed by time sequence and numerical sequence. Check the sessions and name the sessions you would like to save in the default directory or any location you would like to choose.

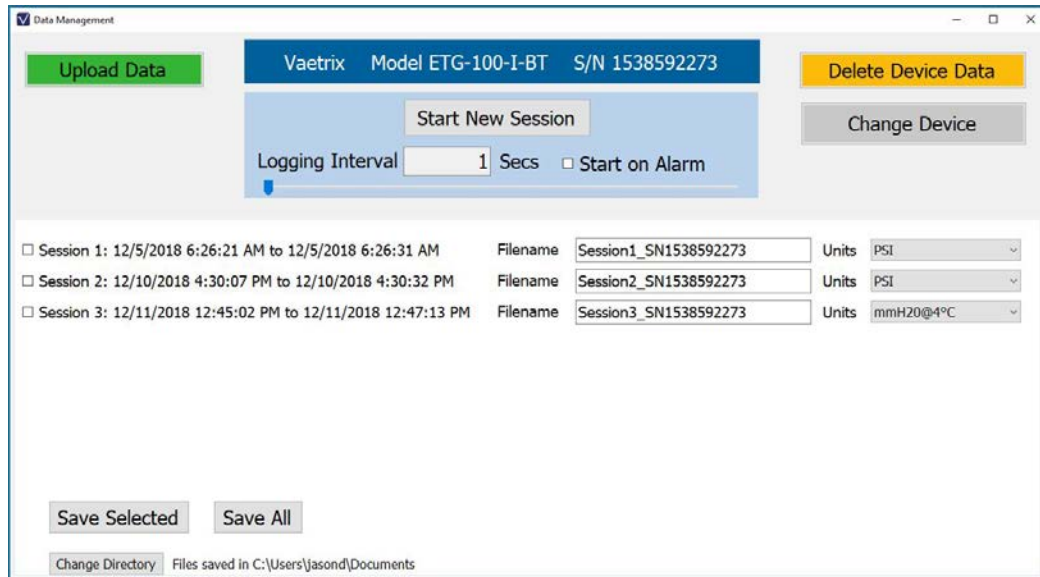

The software will confirm the files are saved with a pop-up box. The software will bring the data in using the engineering unit that is selected on the gauge when the session was started. There is the option to change the engineering units by using the dropdown menu.

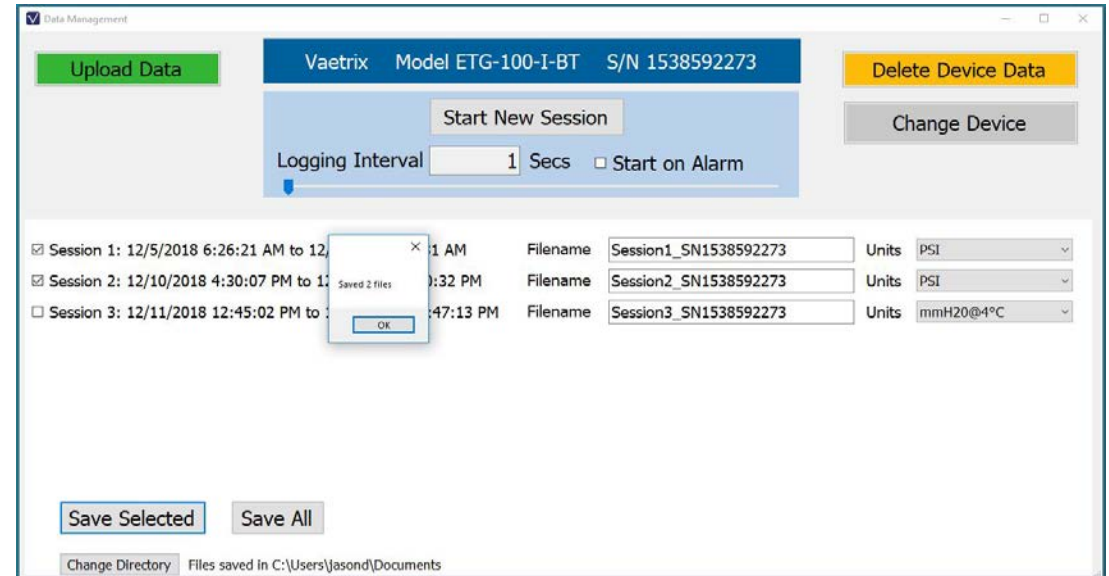



## • Datalogging Application

Sessions will be brought in as a Microsoft® Excel Worksheet with two tabs (Report and Data). The Data tab will provide the raw data with the gauge information, settings, and date/time stamp.

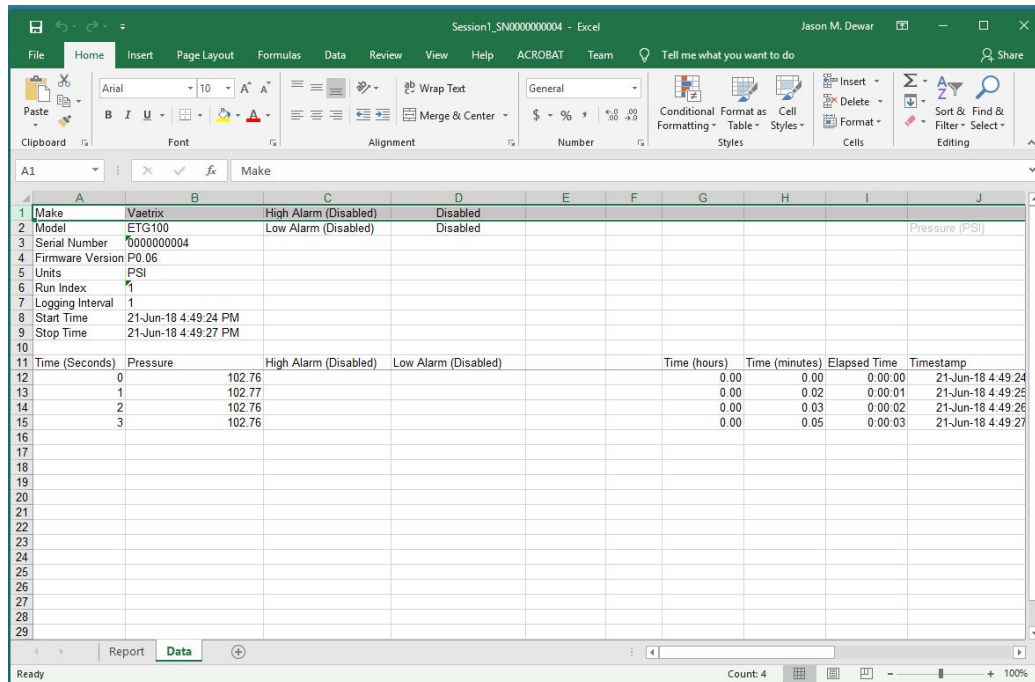

The Report tab will bring the data in using a preformatted report with graphing function. Individual datapoints can be displayed by hovering the mouse or pointer device on the graph.

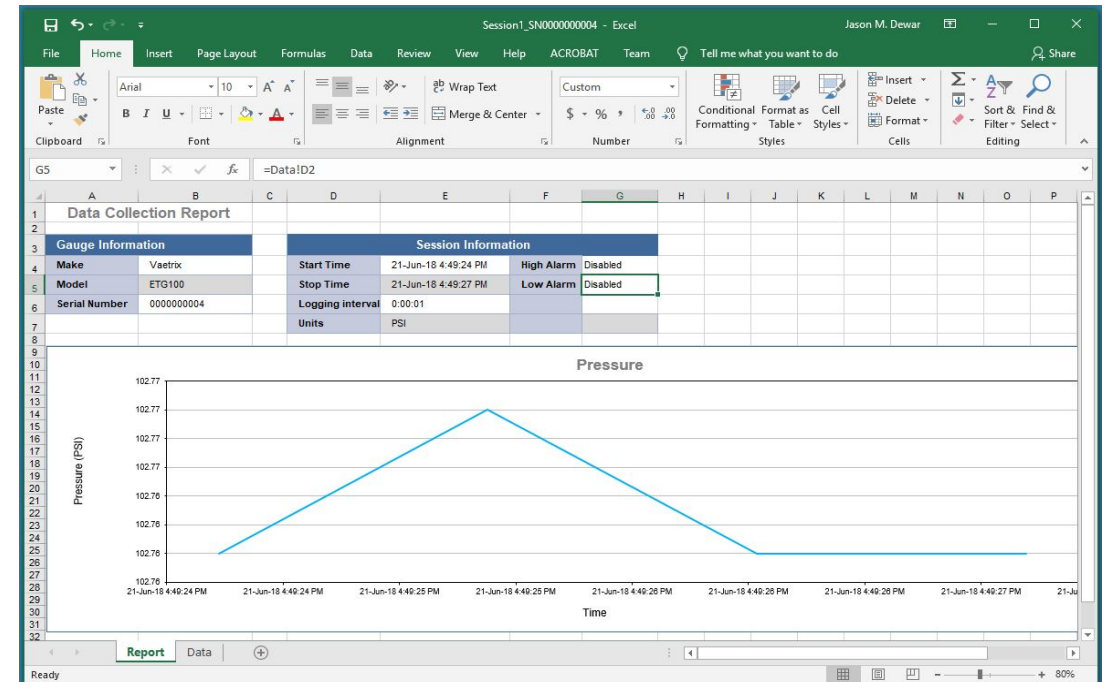

<b>Power</b>	3AA Alkaline Batteries (LR6)
<b>Dimensions</b>	5.95" x 4.08" x 1.65" (Length x Diameter x Depth)
<b>Weight</b>	1.77 Pounds (803 Grams)
<b>Case</b>	Corrosion Resistant Aluminum (Powder Coated)
<b>Display</b>	Tri-Color Graphics Display, 240 x 120 – Real True Type Font Digits (0.6"/15.2 mm high), Protected with Polycarbonate
<b>Positive Pressure Accuracy</b>	±0.05% Full Scale, ±0.1% Full Scale, or ±0.25% Full Scale <i>See range options for details</i>
<b>Vacuum Accuracy</b>	±0.25% Full Scale <i>Applies to pressure range of 500 psi and below with an isolated sensor. All units will read vacuum. They are not to be used in a continuous vacuum below -14 psi with the exception of the compound sensors.</i>
<b>Barometric Accuracy</b>	±0.35% Full Scale <i>Full Scale value = 35.42"Hg or 17.4 psia</i>

<b>Operating Temperature</b>	14°F to 122°F (-10°C to 50°C) <i>Compensated range</i>
<b>Storage Temperature</b>	-10°F to 150°F (-23°C to 65°C) <i>Remove batteries for storage over thirty days</i>
<b>Humidity</b>	0%-95% (Non-Condensing)
<b>IP Rating</b>	IP65 Handheld and IP54 (Panel Mount – Front)
<b>Low Battery Indication</b>	3.7 Volts, 3.5 Volts - Shutdown
<b>Battery Life</b>	Typical Use (Duracell Ultra) 1000 Hours – Backlight On in Measure Mode 1500 Hours - No Display Datalogging at 1 Second Interval
<b>Memory</b>	Non-Volatile Flash Memory, 64000 Samples, 200 Sessions
<b>Output</b>	USB – MICRO B
<b>Fitting</b>	¼" MNPT
<b>Over Pressure</b>	120% Native Full Scale Range <i>Display indicates Over Range</i>
<b>Burst Pressure</b>	3X Native Full Scale on Most Ranges <i>Consult range options for details</i>

# Specifications



<b>Update Rate</b>	4 Readings Per Second
<b>Units</b>	23 Selectable, 1 Custom
<b>Bluetooth</b>	Optional BLE Low Energy, Registered Under FCC: WAP2001
<b>Warranty</b>	4 Years – Register product at <a href="http://www.vaetrix.com">www.vaetrix.com</a> .



# Specifications (Panel Mount)



<b>Power</b>	5 Volts (USB – Micro B) 50-60 Hz (100V-240V) AC Adapter Provided
<b>Dimensions</b>	5.26" Outer Diameter x 4.08" Inner Diameter x 3.1" Depth
<b>Weight</b>	1.7 Pounds (771 Grams)

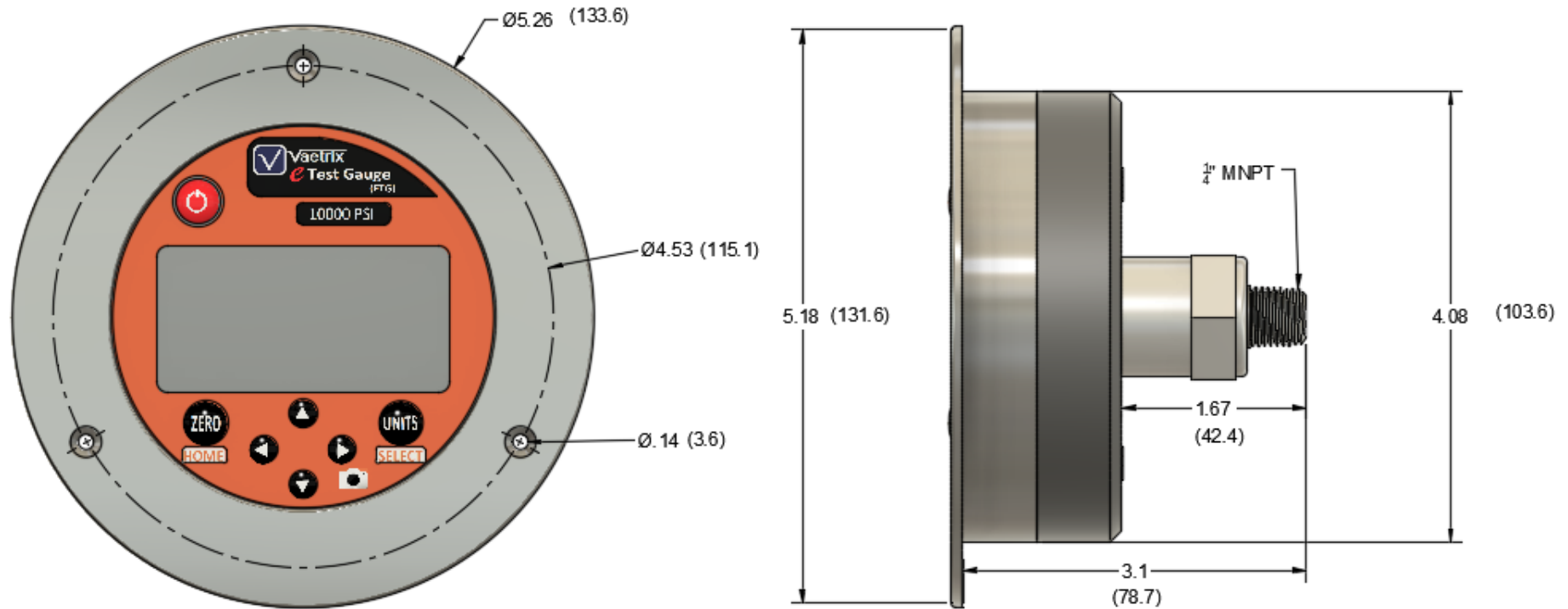

# Range Options (0.05% Full Scale)



Range (PSI)	Full Scale/Span	Sensor Type	Burst	Media
15	±15	C	3x	G (Clean, Dry Gas)
30	±30	C	3x	G (Clean, Dry Gas)
15	-12 to 15	I	3x	L (Gas and Liquids compatible with 316SS)
30	-12 to 30	I	3x	L (Gas and Liquids compatible with 316SS)
100	-12 to 100	I	3x	L (Gas and Liquids compatible with 316SS)
300	-12 to 300	I	3x	L (Gas and Liquids compatible with 316SS)
500	-12 to 500	I	3x	L (Gas and Liquids compatible with 316SS)
1K	0 to 1000	I	3x	L (Gas and Liquids compatible with 316SS)
3K	0 to 3000	I	3x	L (Gas and Liquids compatible with 316SS)
5K	0 to 5000	I	3x	L (Gas and Liquids compatible with 316SS)
10K	0 to 10000	I	2x	L (Gas and Liquids compatible with 316SS)

# Range Options (0.1% and 0.25% Full Scale)



Range (PSI)	Full Scale/Span	Sensor Type	Burst	Media
5	±5	I	3x	L (Gas and Liquids compatible with 316SS)
30	-12 to 30	I	2x	L (Gas and Liquids compatible with 316SS)
100	-12 to 100	I	2x	L (Gas and Liquids compatible with 316SS)
500	-12 to 500	I	2x	L (Gas and Liquids compatible with 316SS)
1000	0 to 1000	I	2x	L (Gas and Liquids compatible with 316SS)
3K	0 to 3000	I	2x	L (Gas and Liquids compatible with 316SS)
5K	0 to 5000	I	1.5x	L (Gas and Liquids compatible with 316SS)
10K	0 to 10000	I	1.5x	L (Gas and Liquids compatible with 316SS)
14.5K	0 to 14500	I	1.5x	L (Gas and Liquids compatible with 316SS)



Model	Range (PSI)	Sensor / Media	Accuracy	Options
ETG = Portable Handheld ETGP = Panel Mount	15 30 100 300 500 1000 3000 5000 10000	I = Isolated C = Compound	05 = 0.05% Full Scale	BT = Bluetooth BLE EX = Intrinsically Safe (Pending)
ETG = Portable Handheld	5 30 100 500 1000 3000 5000 10000 14500	I = Isolated	10 = 0.1% Full Scale 25 = 0.25% Full Scale	BT = Bluetooth BLE EX = Intrinsically Safe (Pending)

# Range and Native Resolution



Range (PSI)	PSI	BAR	MBAR	KGCM2	INH2O 4, 20, 60	CMH2O 4, 20	MMH2O 4, 20	MSW	FTH2O 20, 60	FTSW	INHG	MMHG	KPA	MPA	TORR	
5	5.0001	0.3441	344.01	0.0001	138.01	351.01	3515.1	3.0001	11.001	11.001	10.001	258.01	34.001	0.0001	258.01	
15	15.001	1.0001	1034.1	1.0001	415.01	1054.1	10546	10.001	34.001	33.001	30.001	775.01	103.01	0.1001	775.01	
30	30.001	2.0001	2068.1	2.0001	830.01	2109.1	21093	20.001	69.001	67.001	61.001	1551.1	206.01	0.2001	1551.1	
100	100.01	6.0001	6894.1	7.0001	2768.1	7030.1	70309	68.001	230.01	224.01	203.01	5171.1	689.01	0.6001	5171.1	
300	300.01	20.001	20684	21.001	8304.1	21093		205.01	692.01	673.01	610.01	15515	2068.1	2.0001	15515	
500	500.01	34.001	34474	35.001	13840	35154		341.01	1153.1	1121.01	1018.01	25858	3447.1	3.0001	25858	
1000	1000.1	68.001	68948	70.001	27681	70309		683.01	2306.1	2243.01	2036.0	51715	6894.1	6.0001	51715	
3000	3000.1	206.01		210.01	83042			2051.01	6920.1	6730.01	6108.1		20684	20.001		
5000	5000.1	344.01		351.01				3419.1	11534	11218	10180		34474	34.001		
10000	10000	689.01		703.01				6838.1	23067	22436	20360		68948	68.001		
14500	14500	999.01		1019.1				9915.1	33447	32625	29522		99974	99.001		

- 1.) Not displayed due to resolution and available A/D counts.
- 2.) Display Resolution can be adjusted under ADMIN feature in Menu.

- Service and Product Registration

To initiate the service process on your Vaetrix product complete the RMA form located on the website ([www.vaetrix.com](http://www.vaetrix.com)) or feel free to give us a call. Please have the model number, serial number, and reason for return available so that we can walk you through the process.

It is important to register your product to ensure you receive the full forty eight month or four year product warranty. Registration can be completed online at [www.vaetrix.com](http://www.vaetrix.com) or by phone. If the product is not registered within ninety days from purchase through an authorized partner, Vaetrix reserves the right to honor the full product warranty at our discretion.

- Warranty

Upon registration, Vaetrix warrants our products against manufacturing defects and workmanship for a period of forty eight months from the date of shipment to the original buyer. If you fail to register the product, a limited twelve month warranty will remain in effect. Vaetrix will repair or replace any defective device at no charge, this includes shipping charges. All warranty claims will be evaluated to determine if the claim was caused by product alteration, misuse, or use outside the published specifications. If we determine the root cause was due to negligence, there will be charges for the work completed in order to bring the product to the original published specifications. Please consult the website for details on returning the product.

Vaetrix under no circumstances shall be liable for amount greater than the product value at time of purchase. This includes and incidental, consequential, or special damages that may have occurred during use. This statement of warranty is in lieu of all other warranties, guarantees, liabilities and obligations, statutory or implied to the original purchase or to any other party.